

# Specification

Customer name : \_\_\_\_\_

Production name : SMD2835SW-H

Moder : HZ-SMD2835SW-H

Part number : 20140315004

Date : 15 - Mar.- 2014

Client approval			Huazhoug approval		
Approval	Audit	Confirmation	Approval	Audit	Confirmation

## Features

- Extremely wide viewing angle.
- Suitable for all SMT assembly and solder process.
- Available on tape and reel
- Moisture sensitivity level:level 4.
- Package:4000pcs/reel..
- RoHS compliant.

## Description

The White LED which was fabricated using a blue chip and the phosphor

## Applications

- Optical indicator
- Indoor display
- Automotive lighting
- Backlight for LCD,switch and Symbol,display
- Tubular light application
- General use

### Package Dimensions

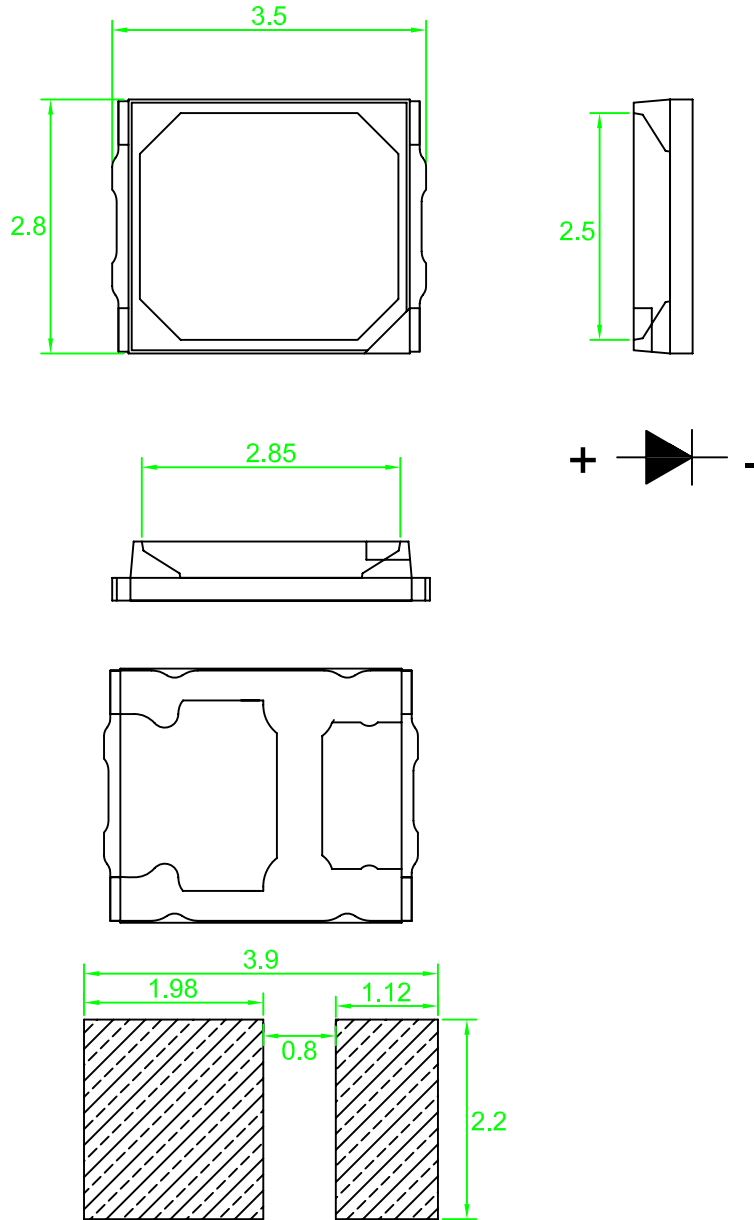

2835PCB图

Note : 1.All dimension are in millimeter tolerance is  $\pm 0.1$ mm unless otherwise noted.  
 2.Specifications are subject to change without notice.

## Absolute Maximum Ratings at Ta=25 °C

Parameter	Symbol	Ratings	UNIT
Forward Current	IF	60	mA
Peak Forward Current Duty 1/10@10KHz	IFP	150	mA
Power Dissipation	PD	210	mW
Reverse Voltage	VR	5	V
Electrostatic Discharge	ESD	1000	V
Operating Temperature	Topr	-40~ +80	°C
Storage Temperature	Tstg	-40~ +100	°C
Soldering Temperature	Tsol	Max 235°C for 3 sec Max	

## Typical Electrical &amp; Optical Characteristics (Ta=25 °C)

Item	Symbol	Test condition	Min	Type	Max	Unit
Forward Voltage	VF	IF=60mA	2.8	3.2	3.4	V
Reverse Current	IR	VR=5V	—	—	10	uA
Luminous Flux	Im	IF=60mA	24	26	—	lm
Color Coordinates	X	IF=60mA	—	0.380	—	—
	Y	IF=60mA	—	0.375	—	
Color Temperature	Tc	IF=60mA	—	4000	—	K
Viewing Angle	2θ 1/2	IF=60mA	—	120	—	deg
Color Rendering Index	Ra	IF=60mA	80	—	—	—

Note : 1.The forward voltage data did not including  $\pm 0.1V$  testing tolerance.

2. The luminous intensity data did not including  $\pm 15\%$  testing tolerance.

### Color Group

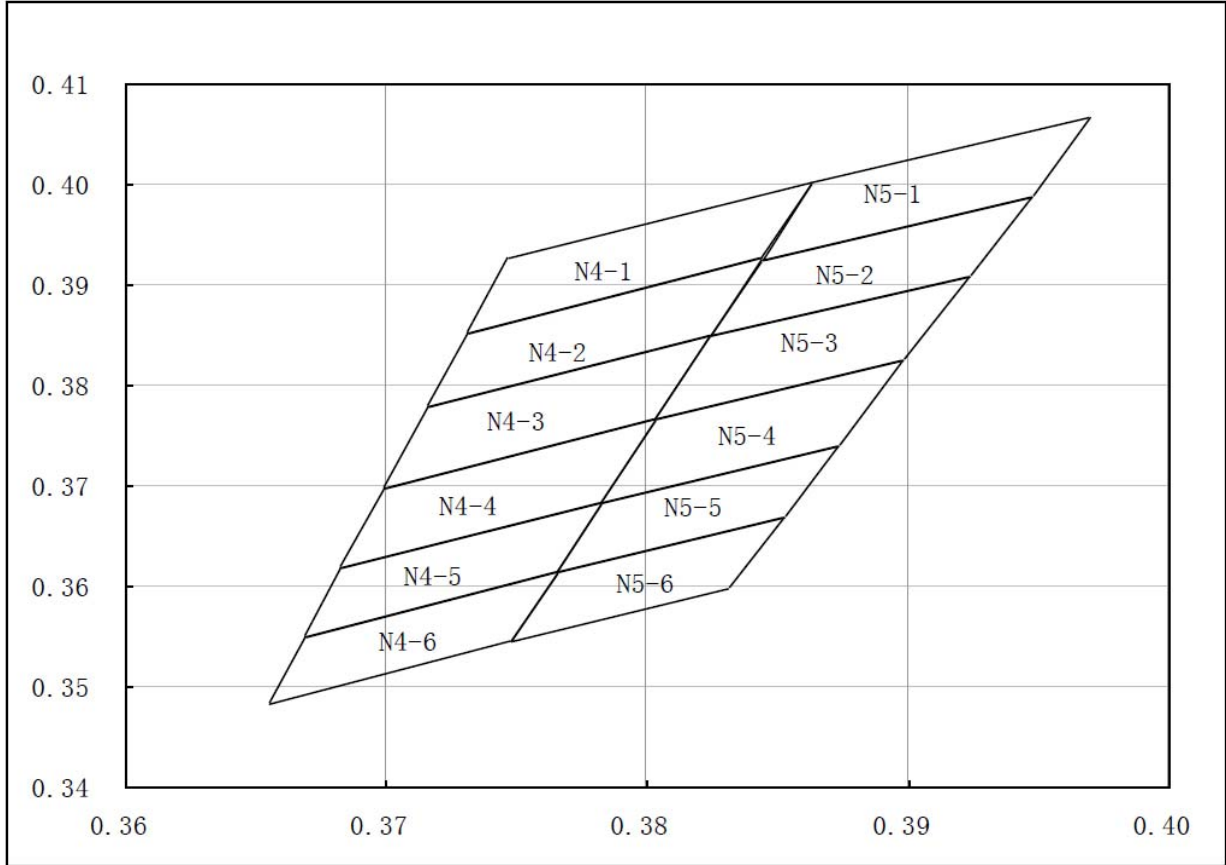

N4-1 4000-4250K					N4-2 4000-4250K					N4-3 4000-4250K				
x	0.3746	0.3863	0.3844	0.3731	x	0.3731	0.3844	0.3824	0.3716	x	0.3716	0.3824	0.3803	0.3699
y	0.3927	0.4003	0.3927	0.3853	y	0.3853	0.3927	0.3850	0.3779	y	0.3779	0.3850	0.3767	0.3699
N4-4 4000-4250K					N4-5 4000-4250K					N4-6 4000-4250K				
x	0.3699	0.3803	0.3782	0.3682	x	0.3682	0.3782	0.3765	0.3669	x	0.3669	0.3765	0.3748	0.3655
y	0.3699	0.3767	0.3684	0.3618	y	0.3618	0.3684	0.3615	0.3551	y	0.3551	0.3615	0.3546	0.3484
N5-1 3800-4000K					N5-2 3800-4000K					N5-3 3800-4000K				
x	0.3863	0.3970	0.3947	0.3844	x	0.3844	0.3947	0.3923	0.3824	x	0.3824	0.3923	0.3898	0.3803
y	0.4003	0.4066	0.3987	0.3927	y	0.3927	0.3987	0.3908	0.3850	y	0.3850	0.3908	0.3824	0.3767
N5-4 3800-4000K					N5-5 3800-4000K					N5-6 3800-4000K				
x	0.3803	0.3898	0.3873	0.3782	x	0.3782	0.3873	0.3852	0.3765	x	0.3765	0.3852	0.3831	0.3748
y	0.3767	0.3824	0.3740	0.3684	y	0.3684	0.3740	0.3669	0.3615	y	0.3615	0.3669	0.3597	0.3546

# Typical Electro-Optical Characteristics Curve

DBK CHIP

Fig.1 Forward current vs. Forward Voltage

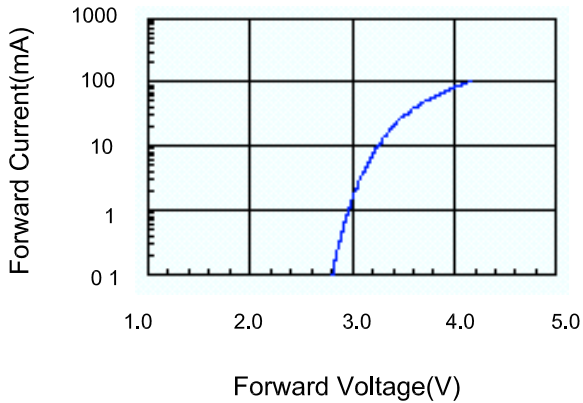

Fig.2 Relative Intensity vs. Forward Current

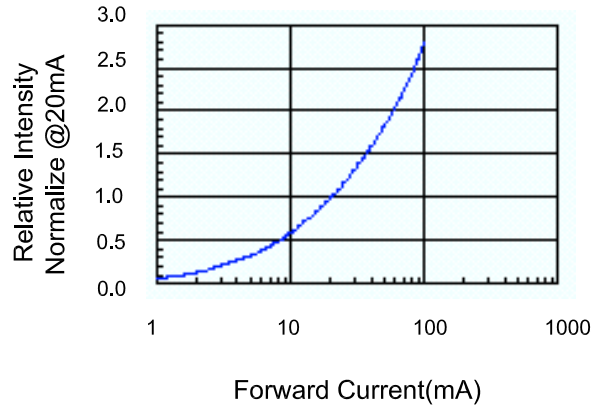

Fig.3 Forward Voltage vs. Temperature

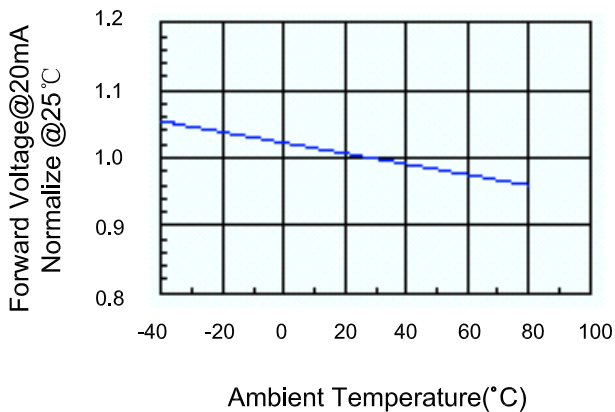

Fig.4 Relative Intensity vs. Temperature

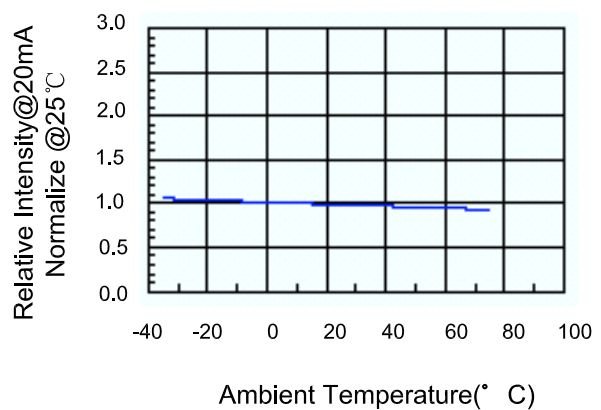
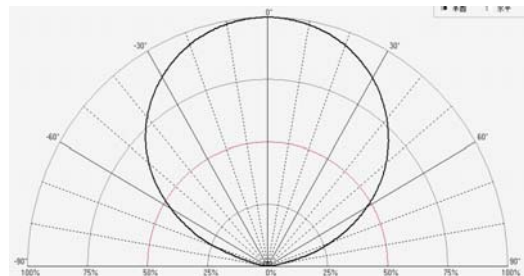
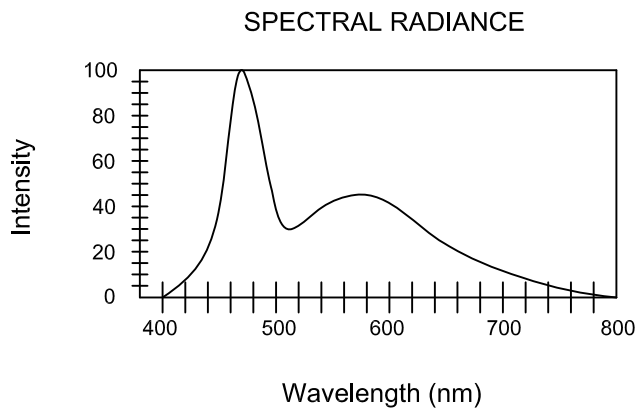

Fig.5 Luminous Spectrum (Ta=25°C)



## Reliability Test:

Test Item	Test Condition	Description	Reference Standard
Operating Life Test	1.Under Room Temperature 2.If=60mA 3.t=1000 hrs (-24hrs, +72hrs)	This test is conducted for the purpose of determining the resistance of a part in electrical and thermal stressed.	MIL-STD-750: 1026 MIL-STD-883: 1005 JIS C 7021: B-1
High Temperature Storage Test	1.Ta=100°C±5°C 2.t=1000 hrs (-24hrs, +72hrs)	The purpose of this is the resistance of the device which is laid under condition of high temperature for hours.	MIL-STD-883:1008 JIS C 7021: B-10
Low Temperature Storage Test	1.Ta=-40°C±5°C 2.t=1000 hrs (-24hrs, +72hrs)	The purpose of this is the resistance of the device which is laid under condition of low temperature for hours.	JIS C 7021: B-12
High Temperature High Humidity Test	1.Ta=65°C±5°C 2.RH=90%~95% 3.t=240hrs±2hrs	The purpose of this test is the resistance of the device under tropical for hours.	MIL-STD-202:103B JIS C 7021: B-11
Thermal Shock Test	1.Ta=100°C±5°C&-40°C±5°C (10min) (10min) 2.total 10 cycles	The purpose of this is the resistance of the device to sudden extreme changes in high and low temperature.	MIL-STD-202: 107D MIL-STD-750: 1051 MIL-STD-883: 1011
Solder Resistance Test	1.T.Sol=260°C±5°C 2.Dwell time= 10 ± 1sec.	This test intended to determine the thermal characteristic resistance of the device to sudden exposures at extreme changes in temperature when soldering the lead wire.	MIL-STD-202: 210A MIL-STD-750: 2031 JIS C 7021: A-1
Solderability Test	1.T.Sol=230°C±5°C 2.Dwell time=5 ± 1sec	This test intended to see soldering well performed or not.	MIL-STD-202: 208D MIL-STD-750: 2026 MIL-STD-883: 2003 JIS C 7021: A-2

## Criteria For Judging Damage

Test Items	Symbol	Test Condition	Test Condition	
			Min.	Max.
Forward Voltage	VF	IF=60mA	--	U.S.L*)x1.1
Reverse Current	IR	VR=5V	--	U.S.L*)x2.0
Luminous Flux	Im	IF=60mA	L,S,L*)x0.7	--

## SMT Reflow Soldering Instructions

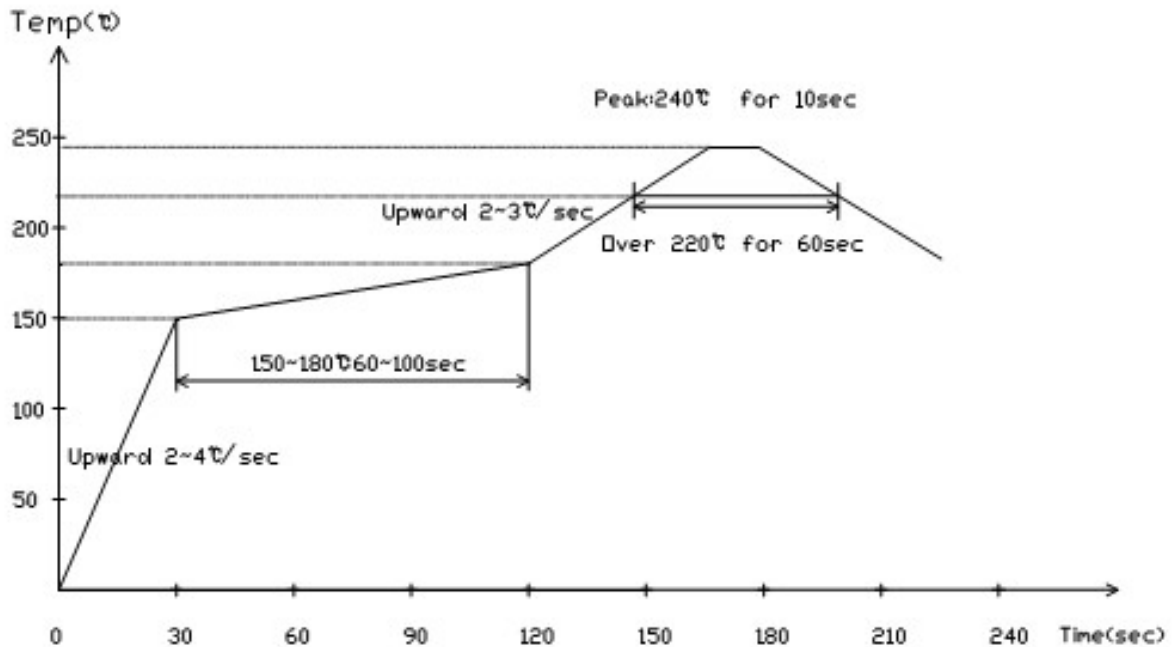

- 1.Reflow soldering should not be done more than two times.
- 2.When soldering,do not put stress on the LEDs during heating

### Soldering iron

- 1.When hand soldering,keep the temperature of iron below less 300° C less than 3 seconds
- 2.The hand solder should be done only one times

### Repairing

Repair should not be done after the LEDs have been soldered.When repairing is unavoidable,a double-head soldering iron should be used (as below figure).It should be confirmed in advance whether the characteristics of LEDs will or will not be damaged by repairing.



## **Cautions**

The encapsulated material of the LEDs is silicone. Therefore the LEDs have a soft surface on the top of package. The pressure to the top surface will be influence to the reliability of the LEDs. Precautions should be taken to avoid the strong pressure on the encapsulated part. So when use the picking up nozzle, the pressure on the silicone resin should be proper.

## **Handling Precautions**

Compare to epoxy encapsulant that is hard and brittle, silicone is softer and flexible. Although its characteristic significantly reduces thermal stress, it is more prone to damage by external mechanical force. As a result, Special handling precautions must be observed during assembling using silicone encapsulated LED products, Failure to comply might leads to damage and premature failure of the LED.

1. Handle the component allong the side surface by using forceps or appropriate tools; do not directly touch or Handle the silicone lens surface, it may damage the internal circuitry.
2. The outer diameter of the SMD pickup nozzle should not exceed the size of the LED to prevent air leaks. The inner diameter of the nozzle should be as large as possible. A pliable material is suggested for the nozzle tip to avoid scratching or damaging the LED surface during pickup. The dimensions of the component must be accurately programmed in the pick-and-place machine to insure precise pickup and avoid damage during production.

3. Do not stack together assembled PCBs containing LEDs. Impact may scratch the silicone lens or damage the internal circuitry.

4. Not suitable to operate in acidic environment,  $\text{PH} < 7$

5. LED operating environment and sulfur element composition cannot be over 100PPM in the LED mating usage material.

6. When we need to use external glue for LED application products, please make sure that the external glue matches the LED packaging glue. Additionally, as most of LED packaging glue is silica gel, and it has strong Oxygen permeability as well as strong moisture permeability; in order to prevent external material from getting into the inside of LED, which may cause the malfunction of LED, the single content of Bromine element is required to be less than 900PPM, the single content of Chlorine element is required to be less than 900PPM, the total content of Bromine element and Chlorine element in the external glue of the application products is required to be less than 1500PPM

7. Other points for attention, please refer to our LED user manual.